

FDW75C2/12N



2525 Park Central Blvd. Decatur, GA 30035
1-800-554-1124 • www.videolarm.com



PRODUCT FEATURES







- Universal mounting plate to accept IP network camera systems
- Available with integral pan/tilt
- Thermostatically controlled 12Vdc or 24Vac heater and surge protection
- Durable engineered plastic top, 94VO UV protected
- Integrated Wall Mount standard; Pendant Mount available (1 1/2" pipe thread)
- Accepts IP Network fixed camera - MCL 7.5"
- Optically clear and durable polycarbonate lower dome

FDW75(2/12)N FusionDome™ Series

PRODUCT DESCRIPTION

The indoor and outdoor 7" FusionDome™ models offers versatility and camera protection in a compact size. It accepts analog camera systems from Canon & Elmo and many network cameras from Axis, Canon, Elmo, JVC, Panasonic and Sony or a single fixed camera with a maximum camera length of 7.5". On outdoor models a heater and blower are standard, and a cold weather kit is available to offer even wider temperature ranges.

OPTIONAL COMPONENTS AND ACCESSORIES:

<p>PB24L Rugged outdoor wireless box, 220/110vac input, 24vac output 2.4GHz, 5.8GHz, or 900Mhz access point. Omni directional antenna.</p> 	<p>CWKFD2 24Vac Cold Weather Kit for an additional heater and blower For Outdoor FusionDomes in extremely cold weather</p> 	<p>PRM30G Aluminum parapet mount bracket with 20" extension, includes 1 1/2" NPT</p> 	<p>PB24 Rugged cast aluminum power box with 84vA and 24vA power supply</p> 	<p>WM20G Aluminum gooseneck wall bracket, includes 1 1/2" NPT</p> 	<p>PS2496N NEMA 4x rated outdoor plastic enclosure, 115Vac input, 24Vac output: 1 Camera output - 1.1A 1 Heater output - 4A (96vA)</p> 	<p>ACA2 Aluminum corner mount bracket with female inserts</p> 	<p>WM30G Aluminum parapet mount bracket, includes 1 1/2" NPT</p> 
---	---	---	---	---	---	--	---

MODELS:

Heater/Blower

FusionDome™ 7"	PTZ	24Vac	12Vdc	Wall Mount
FDW75C12N	√		√	√
FDW75CF2N		√		√
FDW75C2N	√	√		√
IFDP75TF				
IFDP75TN	√			

FusionDome™ MODEL NUMBER SYSTEM:

F	D	W	7	5	C	2	N
Fusion Dome	Wall Mount	Dome with extended trim ring	Clear Dome	PTZ Camera	24Vac Input	IP Ready Network	
IFD	P	7	T	F	12		
Indoor Fusion Dome	Pendant Mount	7" Dome	Tinted Dome	Fixed Camera	12Vdc Input		

FDW75C(2/12)N

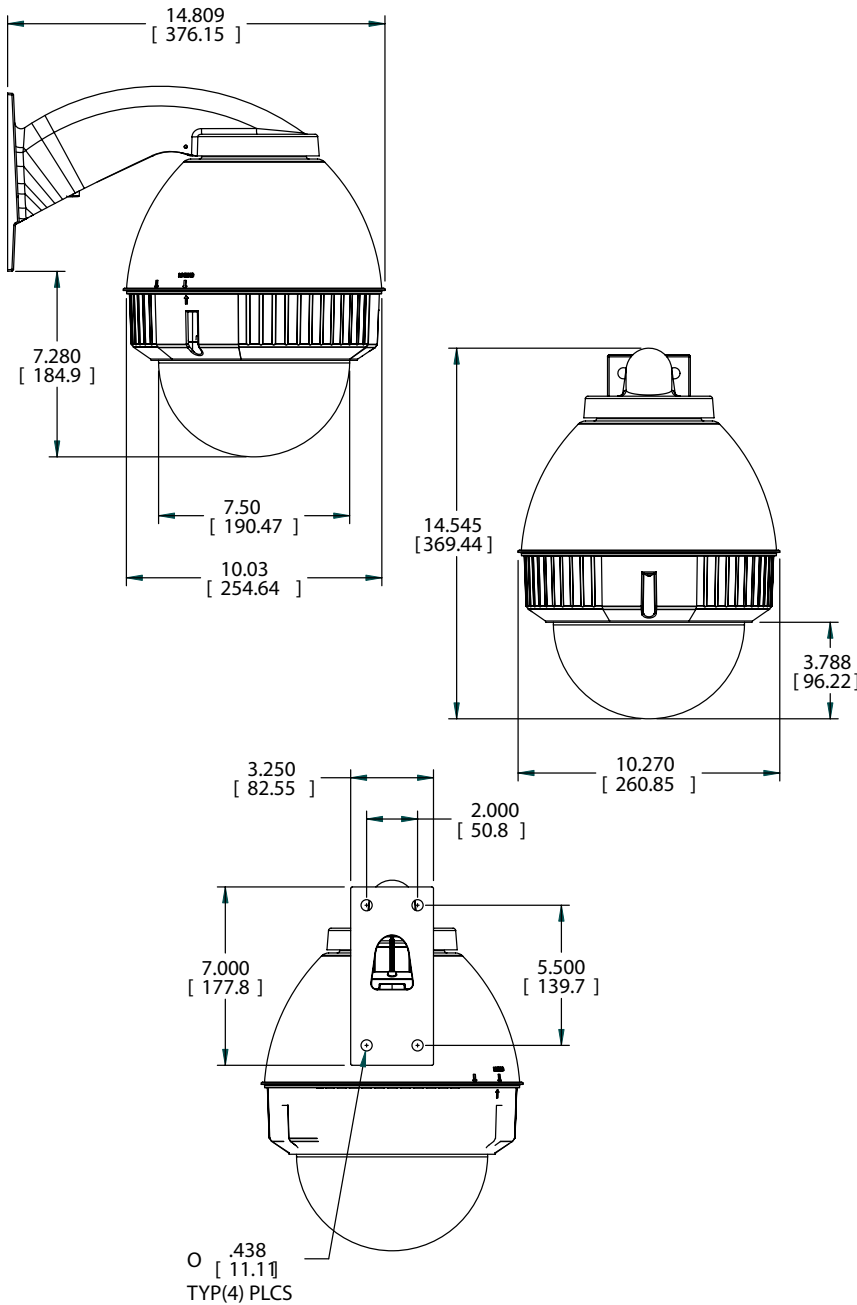

Mechanical Specifications

Size: (Product/shipping)	14.7" x 8.2" x 14.5" (h*w*d) 374 x 208 x 369m
Weight: (Product/shipping)	11 lbs/ 5kg
Construction	Top: 3mm engineered plastic Dome: Polycarbonate Mount Bracket: Machined & cast aluminum

Environmental Specifications

Operating Temperature:	-20° F to + 120° F -29° C to + 49° C
Heater activates at	60 °F (15° C)
Heater deactivates at	80°F (27° C)
Effective Projected Area (EPA):	Approx. 0.12 m^2
Operating Humidity:	Up to 100%

Electrical Specifications

Power:	Dome 24vac model: 24vac 55watts (H/B 27 watts) Dome 12vdc model: 12vdc, 50 watts (includes 20 watts for heater)
--------	--

Shipping Specifications

Model	Shipping Weight	Box Dim.
FDW75	11 lbs	17 x 14 x 17
FDP75	11 lbs	13 x 13 x 20

FDW75C(2/12)N
FusionDome™ Series
CERTIFICATIONS AND RATINGS



ARCHITECTURAL/ENGINEERING SPECIFICATIONS

For standard outdoor applications the camera shall be housed in an FDW75 enclosure, which is available in either wall or pendant mounted versions. Blowers and thermostatically controlled heaters shall be included. Outdoor units shall be a 24Vac input. The housing top shall be manufactured from high-impact engineered plastic, UV protected, with a UL flame rating of 94V0. The dome shall be made of optically clear injection molded polycarbonate, and shall be held in place with 3 captive fasteners. Both clear and tinted domes shall be available. A safety cable shall be provided to hold the dome while servicing. For outdoor models that support network cameras the input voltage is 24vac and the housing shall include 24vac to 12vdc power supply for the camera. For the JVC VN-C655U the output power to the camera is 18vdc.